

MAGNETIC LED track light OSAKA 3 W Datasheet

Number of heads	1
Mounting	Track mounting
Lamps description	LED 3 W, CRI 90
Luminaire luminous flux	80 lm/W
Voltage (V)	48
Environment	Indoor
Notes	MAGNETIC track lights are a new generation of innovative lighting systems.

OPTICAL

Reflector finish	Aluminum, PVC
Aiming	Adjustable 360° and 90°
Light distribution symmetry	Symmetric
Beam angle	7°
Color temperature	3000K, 4000K

ELECTRICAL

Wattage	3 W
Transformer mounting	Integral
Transformer type	Electronic
Frequency	50-60 HZ
Voltage	48 V

PHYSICAL

Spot diameter (mm)	Ø 18
Construction material	Aluminium, PVC
Weight (kg)	0,09
Luminaire lifespan	30 000h
LED module	OSRAM COB LED Flicker free
Driver	48 V
Working temperature	0 to +40 °C
Warranty	3 years from purchase date



Magnetic LED light to be installed on 48 V magnetic track

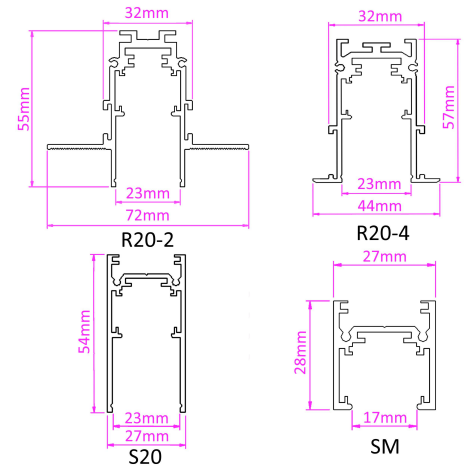

● Black ● White

Dimensions: Ø30 x 60mm

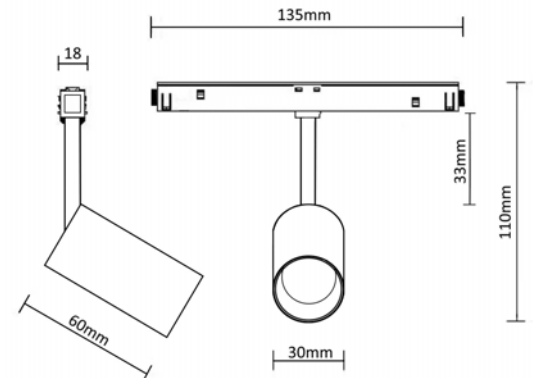
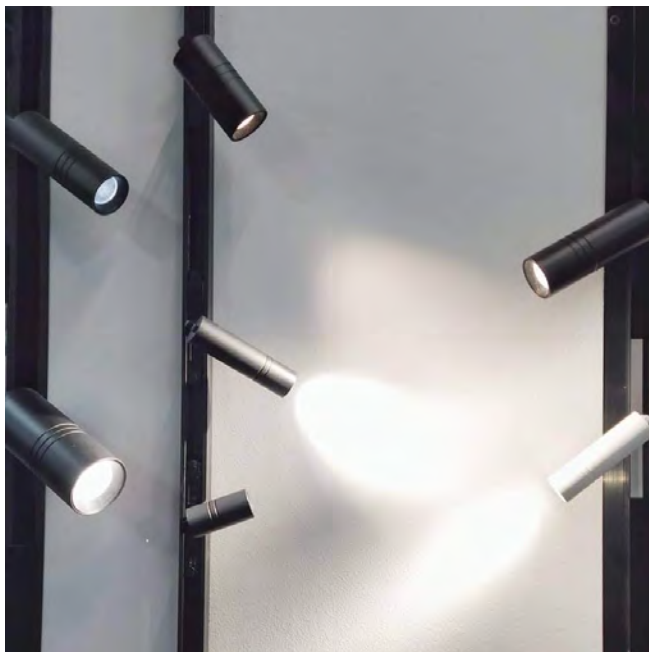

CERTIFICATIONS

