

MAGNETIC LED track light OSAKA 18 W Datasheet

Number of heads	1
Mounting	Track mounting
Lamps description	LED 18 W, CRI 90
Luminaire luminous flux	80 lm/W
Voltage (V)	48
Environment	Indoor
Notes	MAGNETIC track lights are a new generation of innovative lighting systems.

OPTICAL

Reflector finish	Aluminum, PVC
Aiming	Adjustable 360° and 90°
Light distribution symmetry	Symmetric
Beam angle	36°
Color temperature	3000K, 4000K

ELECTRICAL

Wattage	18 W
Transformer mounting	Integral
Transformer type	Electronic
Frequency	50-60 HZ
Voltage	48 V

PHYSICAL

Spot diameter (mm)	Ø 42
Construction material	Aluminium, PVC
Weight (kg)	0,4
Luminaire lifespan	30 000h
LED module	BRIDGELUX COB LED
Driver	Flicker free 48 V
Working temperature	0 to +40 °C
Warranty	3 years from purchase date



Magnetic LED light to be installed on 48 V magnetic track

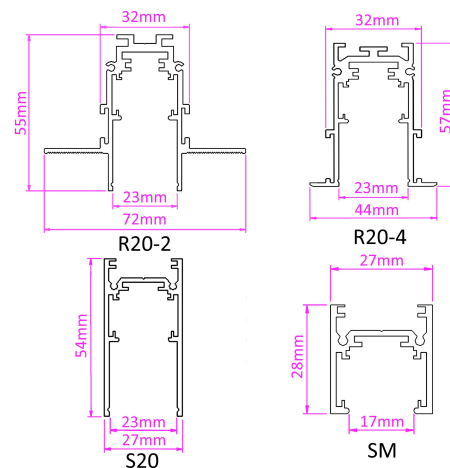

● Black ● White

Dimensions: Ø60 x 150mm

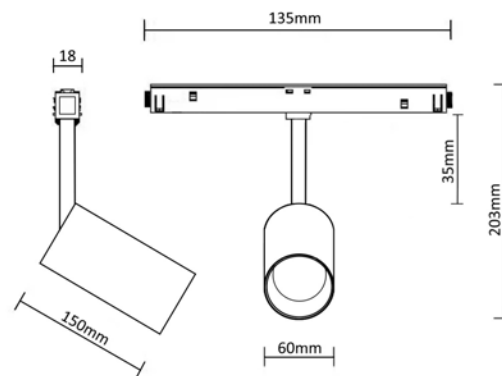
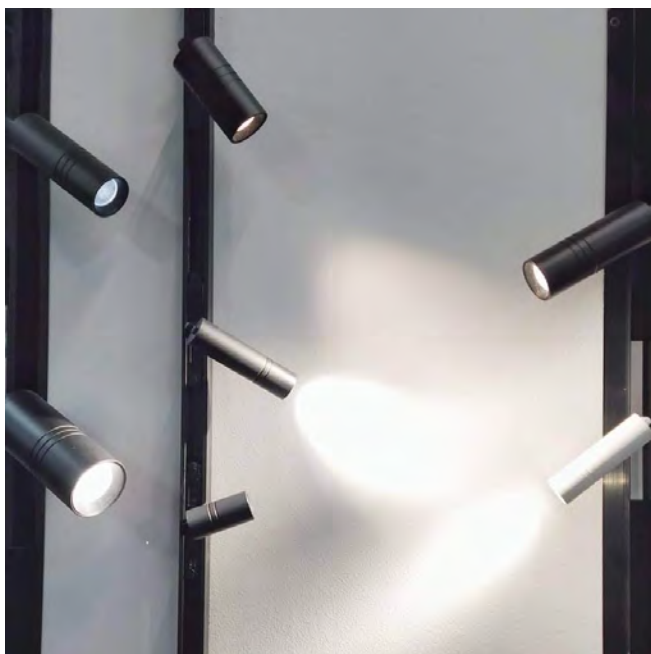

CERTIFICATIONS

