



UPSHINE<sup>®</sup>



Technical Application  
Guide for UP-SHINE  
LED Downlight

UP-CL102A-2.5-8W

# Introduction

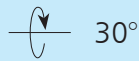

CL102 LED recessed downlight adopts super slim and compact design, perfectly suitable for the narrow ceiling installation. IP65 rating front cover design, suitable for damp environment. Traditional diamond plaited surface lens design ensures the high light transmittance and uniform lighting output. T-shape heat sink greatly increases the radiation area and improves cooling efficiency. The fitting could be rotated from 0 to 30 degree in horizontal direction, which can expand the illumination area.

- Up to 70% energy saving compared to standard CFL
- Long lifetime of 40,000 hours
- Triac dim, 0-10V dim, DALI dim
- 36°/60° wide beam angle
- Ø68-72mm cutout
- CCT: 2700K 3000K  
4000K 5000K
- No UV/IR light
- Environment friendly, without Mercury or any other hazardous substances

## Application notes

- Professional electrician for installation only
- Switch off before installation
- Do not touch when in use
- Keep away from hot steam and corrosive gas

## Application Areas

It is designed for general lighting applications in office, supermarket, shop, school, hotel, etc. It is also widely used for public areas, such as stairway, lobby, reception, corridors etc.

## Certificate

CE RoHS SAA



# Product Information

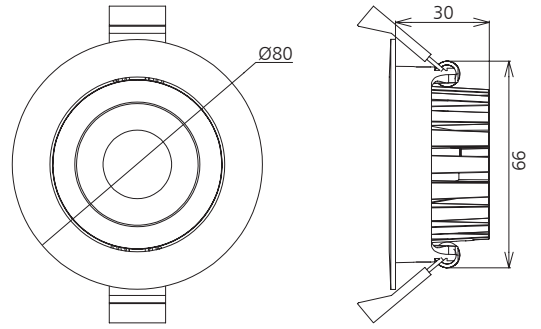

## Technical Specifications

Model	Voltage	Power	Power Factor	Lumen (±5%)	Beam angle	CCT	Lifespan	CRI	Dimmable	Dimension
UP-CL102A-2.5-8W	AC230V	8W	≥0.9	700	36°/60°	2700K	40000h	≥80	No	Ø80*30mm cutout Ø68-72mm
UP-CL102A-2.5-8W	AC230V	8W	≥0.9	735	36°/60°	3000K	40000h	≥80	No	Ø80*30mm cutout Ø68-72mm
UP-CL102A-2.5-8W	AC230V	8W	≥0.9	815	36°/60°	4000K	40000h	≥80	No	Ø80*30mm cutout Ø68-72mm
UP-CL102A-2.5-8W	AC230V	8W	≥0.9	800	36°/60°	5000K	40000h	≥80	No	Ø80*30mm cutout Ø68-72mm
UP-CL102A-2.5-8W-D	AC230V	8W	≥0.9	695	36°/60°	2700K	40000h	≥80	Yes	Ø80*30mm cutout Ø68-72mm
UP-CL102A-2.5-8W-D	AC230V	8W	≥0.9	720	36°/60°	3000K	40000h	≥80	Yes	Ø80*30mm cutout Ø68-72mm
UP-CL102A-2.5-8W-D	AC230V	8W	≥0.9	805	36°/60°	4000K	40000h	≥80	Yes	Ø80*30mm cutout Ø68-72mm
UP-CL102A-2.5-8W-D	AC230V	8W	≥0.9	780	36°/60°	5000K	40000h	≥80	Yes	Ø80*30mm cutout Ø68-72mm
UP-CL102A-2.5-8W	AC230V	8W	≥0.9	535	36°/60°	2700K	40000h	≥90	No	Ø80*30mm cutout Ø68-72mm
UP-CL102A-2.5-8W	AC230V	8W	≥0.9	570	36°/60°	3000K	40000h	≥90	No	Ø80*30mm cutout Ø68-72mm
UP-CL102A-2.5-8W	AC230V	8W	≥0.9	620	36°/60°	4000K	40000h	≥90	No	Ø80*30mm cutout Ø68-72mm
UP-CL102A-2.5-8W	AC230V	8W	≥0.9	590	36°/60°	5000K	40000h	≥90	No	Ø80*30mm cutout Ø68-72mm
UP-CL102A-2.5-8W-D	AC230V	8W	≥0.9	530	36°/60°	2700K	40000h	≥90	Yes	Ø80*30mm cutout Ø68-72mm
UP-CL102A-2.5-8W-D	AC230V	8W	≥0.9	560	36°/60°	3000K	40000h	≥90	Yes	Ø80*30mm cutout Ø68-72mm
UP-CL102A-2.5-8W-D	AC230V	8W	≥0.9	620	36°/60°	4000K	40000h	≥90	Yes	Ø80*30mm cutout Ø68-72mm
UP-CL102A-2.5-8W-D	AC230V	8W	≥0.9	575	36°/60°	5000K	40000h	≥90	Yes	Ø80*30mm cutout Ø68-72mm

## Driver data Sheet

Driver data	DIM	Non dim
Input rated Voltage	AC230V	AC230V
Frequency	50Hz	50/60Hz
Input Voltage	AC200-240V	AC200-240V
Efficiency	≥78%	≥80%
Total load Wattage	8W±0.5W	8W±0.5W
Power Factor	≥0.9	≥0.9
Rated input current	≤0.045A	≤0.045A
Full load output Voltage	DC28-38V	DC27-42V
Rated output current	180mA	185mA
Output current range	180mA±5%	185mA±5%
Power tolerance	±5%	±5%
Current output tolerance	±5%	±5%
Dimming range	8%-100%	—
Dimmer	Triac dimmers	—
Short circuit protection	PASS	PASS
Over voltage protection	PASS	PASS
Over temperature protection	PASS	PASS
THD	≤20%	≤18%
Withstand voltage	AC3750V	AC3750V

## Fixture Compatibility

Rated Wattage	Electrical Classification	Ingress Protection	Operating Temp	Operating Humidity	Storage Temp
8W	II	IP65	-20°C~45°C	0~90%	-20°C~65°C

# Spectral Distribution

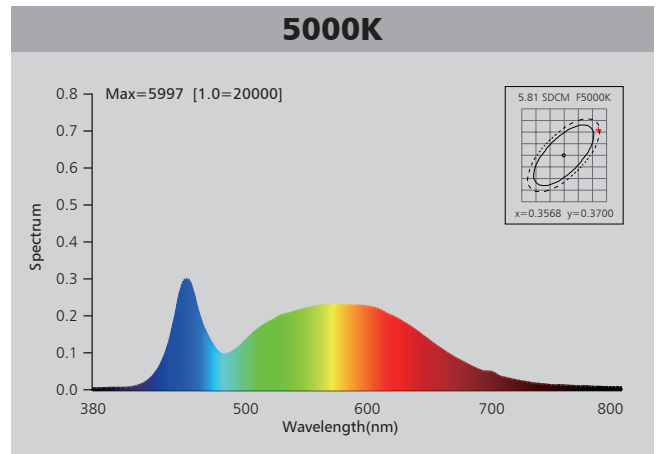
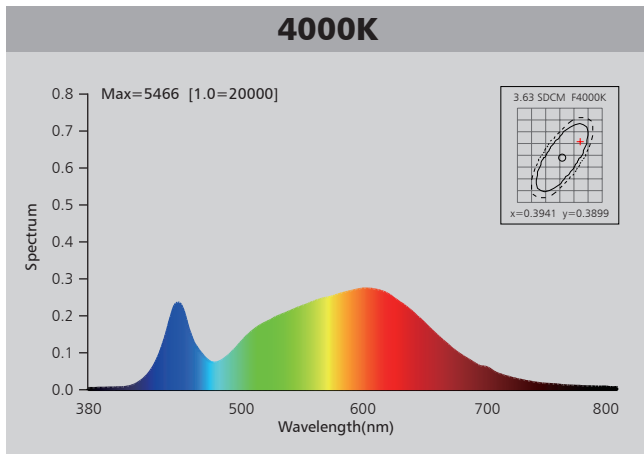
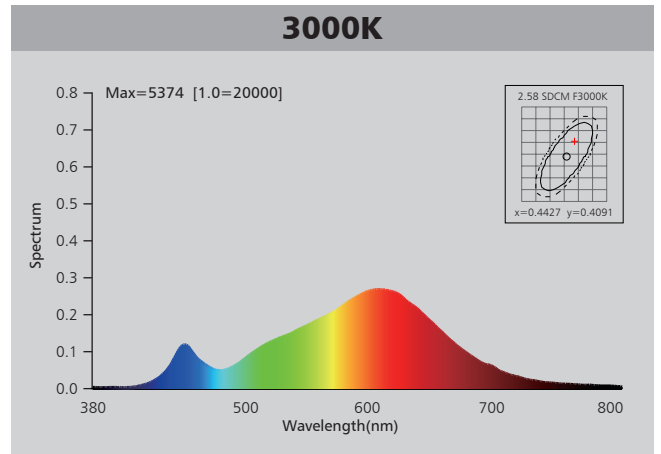
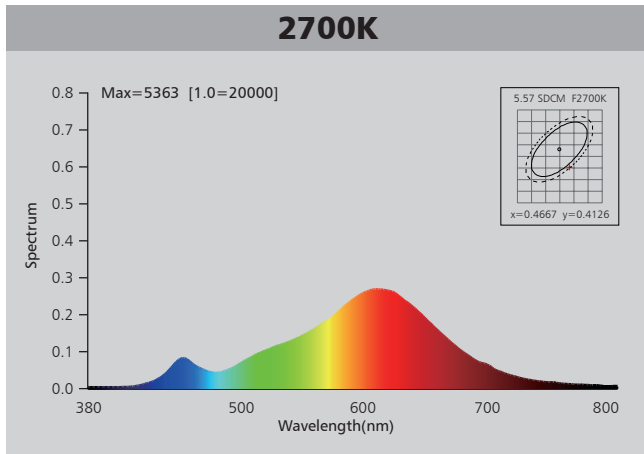

# Photometric Diagram

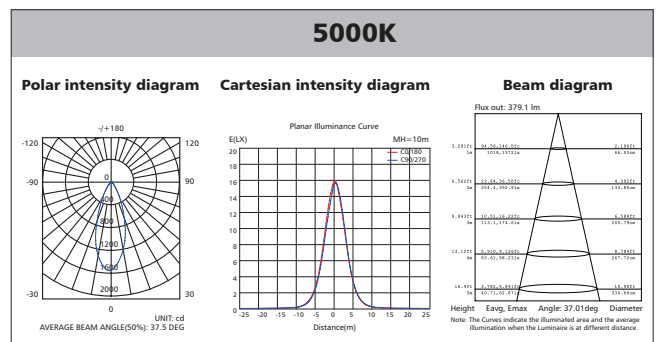
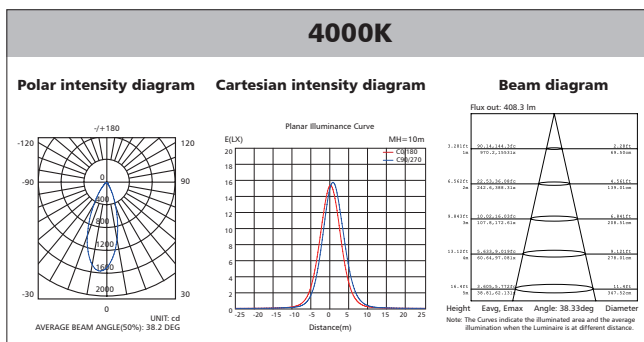
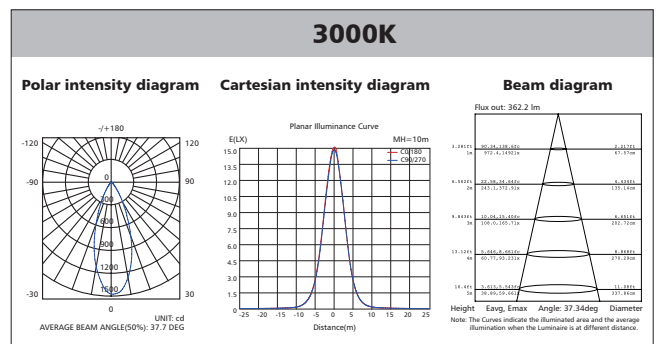
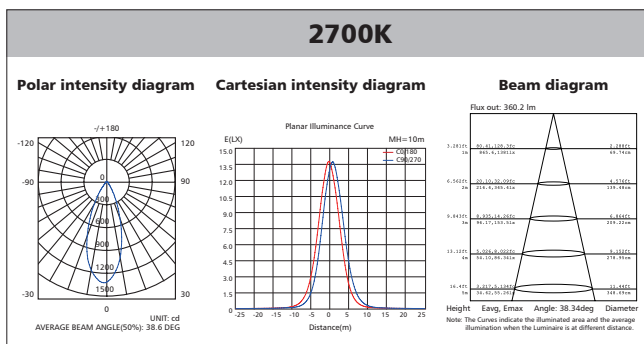

# Polar Diagram Comparison

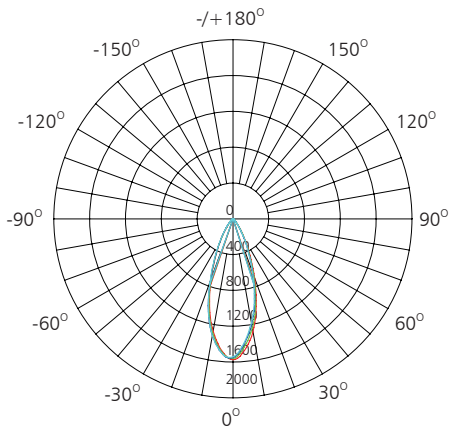

UNIT: cd

- C0/180, 37.7 deg
- C30/210, 37.6 deg
- C60/240, 37.5 deg
- C90/270, 37.4 deg

AVERAGE BEAM ANGLE (50%): 37.5DEG



# Driver lifetime & LED light decay rate

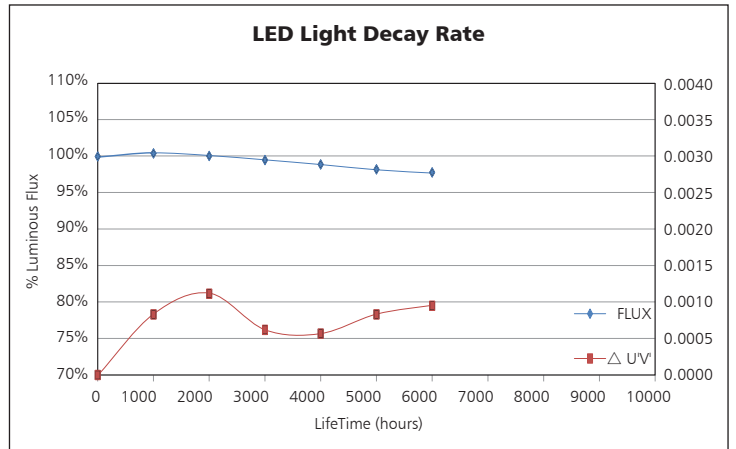
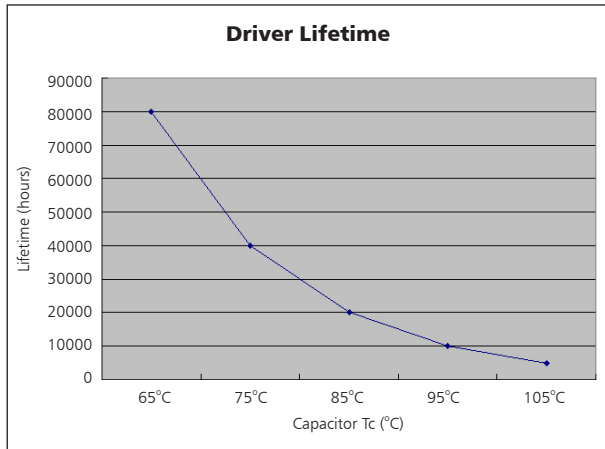

# Temperature

- The testing is operated at 25°C
- The lifetime of capacitor, minimum of 5,000 hours if operated at 105°C, will be doubled whenever the temperature drops 10°C
- The highest withstand temperature of IC, MOS could be 120°C
- The highest withstand temperature of LED junction temperature is 150°C

Time	IC	Capacitor	MOS	PCB	LED	Fitting	Environmental temperature
18:37:46	~65	~55	~65	~25	~50	~45	25
19:07:44	~65	~55	~65	~25	~50	~45	25
19:37:44	~65	~55	~65	~25	~50	~45	25
20:07:44	~65	~55	~65	~25	~50	~45	25
20:37:44	~65	~55	~65	~25	~50	~45	25
21:07:44	~65	~55	~65	~25	~50	~45	25
21:37:44	~65	~55	~65	~25	~50	~45	25
22:07:44	~65	~55	~65	~25	~50	~45	25
22:37:44	~65	~55	~65	~25	~50	~45	25
23:07:44	~65	~55	~65	~25	~50	~45	25
23:37:44	~65	~55	~65	~25	~50	~45	25
0:07:44	~65	~55	~65	~25	~50	~45	25
0:37:44	~65	~55	~65	~25	~50	~45	25
1:07:44	~65	~55	~65	~25	~50	~45	25
1:37:44	~65	~55	~65	~25	~50	~45	25
2:07:44	~65	~55	~65	~25	~50	~45	25
2:37:44	~65	~55	~65	~25	~50	~45	25
3:07:44	~65	~55	~65	~25	~50	~45	25
3:37:44	~65	~55	~65	~25	~50	~45	25
4:07:44	~65	~55	~65	~25	~50	~45	25
4:37:44	~65	~55	~65	~25	~50	~45	25
5:07:44	~65	~55	~65	~25	~50	~45	25
5:37:44	~65	~55	~65	~25	~50	~45	25
6:07:44	~65	~55	~65	~25	~50	~45	25
6:37:44	~65	~55	~65	~25	~50	~45	25
7:07:44	~65	~55	~65	~25	~50	~45	25
7:37:44	~65	~55	~65	~25	~50	~45	25
8:07:44	~65	~55	~65	~25	~50	~45	25
8:37:44	~65	~55	~65	~25	~50	~45	25
9:07:44	~65	~55	~65	~25	~50	~45	25

The driver lifespan is based on capacitor working temperature.

www.upshine.com info@upshine.com

# Installation

Install requirements	
A-gap above the fitting	25mm
B-gap to the building material	25mm
C-gap to the thermal insulation	50mm

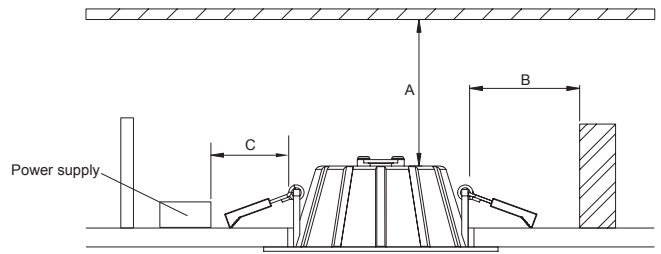

1. Open a hole according to the cutout size of led downlight.

2. Use screw-driver to open the driver terminal cover, feed the main AC wire L. N. in terminal block respectively, then fix the cover back.

3. Connect the downlight with driver, hold back the spring clip then push the downlight into the hole.

4. Make sure the downlight fixed tightly in ceiling, turn on the power (Fig 1).

# Packaging Information

	SIZE(CM)	N.W/pc (KGS)	G.W.(KGS)	Q'TY(PCS)
Carton	52.5*52.5*15	0.24	15	50

	CTNS	Q'TY(PCS)	VOLUME(CBM)
20" standard container	660	33000	28
40" standard container	1320	66000	56

