



UPSHINE®



Technical Application Guide for UP-SHINE LED Downlight

UP-DL103-3-13W

Introduction



DL103 LED recessed downlight adopts super slim and compact design, perfectly suitable for the narrow ceiling installation. IP65 rating front cover design, suitable for damp environment. Traditional diamond plaited surface lens design ensures the high light transmittance and uniform lighting output. T-shape heat sink greatly increases the radiation area and improves cooling efficiency.

- Up to 70% energy saving compared to standard CFL
- Long lifetime of 40,000 hours
- Triac dim, 0-10V dim, DALI dim
- 36°/60° wide beam angle
- Ø90-95mm cutout
- CCT: 2700K 3000K
4000K 5000K
- No UV/IR light
- Environment friendly, without Mercury or any other hazardous substances

Application notes

- Professional electrician for installation only
- Switch off before installation
- Do not touch when in use
- Keep away from hot steam and corrosive gas

Application Areas

It is designed for general lighting applications in office, supermarket, shop, school, hotel, etc. It is also widely used for public areas, such as stairway, lobby, reception, corridors etc.

Certificate

CE **RoHS** **SAA**



Product Information

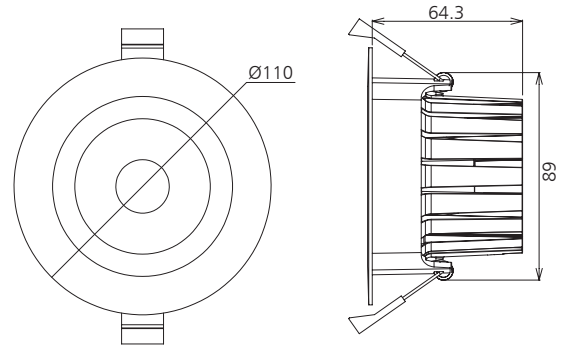

Technical Specifications

| Model | Voltage | Power | Power Factor | Lumen (±5%) | Beam angle | CCT | Lifespan | CRI | Dimmable | Dimension |
|------------------|---------|-------|--------------|-------------|------------|-------|----------|-----|----------|-----------------------------|
| UP-DL103-3-13W | AC230V | 13W | ≥0.9 | 1200 | 36°/60° | 2700K | 40000h | ≥80 | No | Ø110*64.3mm cutout Ø90-95mm |
| UP-DL103-3-13W | AC230V | 13W | ≥0.9 | 1200 | 36°/60° | 3000K | 40000h | ≥80 | No | Ø110*64.3mm cutout Ø90-95mm |
| UP-DL103-3-13W | AC230V | 13W | ≥0.9 | 1350 | 36°/60° | 4000K | 40000h | ≥80 | No | Ø110*64.3mm cutout Ø90-95mm |
| UP-DL103-3-13W | AC230V | 13W | ≥0.9 | 1300 | 36°/60° | 5000K | 40000h | ≥80 | No | Ø110*64.3mm cutout Ø90-95mm |
| UP-DL103-3-13W-D | AC230V | 13W | ≥0.9 | 1130 | 36°/60° | 2700K | 40000h | ≥80 | Yes | Ø110*64.3mm cutout Ø90-95mm |
| UP-DL103-3-13W-D | AC230V | 13W | ≥0.9 | 1130 | 36°/60° | 3000K | 40000h | ≥80 | Yes | Ø110*64.3mm cutout Ø90-95mm |
| UP-DL103-3-13W-D | AC230V | 13W | ≥0.9 | 1300 | 36°/60° | 4000K | 40000h | ≥80 | Yes | Ø110*64.3mm cutout Ø90-95mm |
| UP-DL103-3-13W-D | AC230V | 13W | ≥0.9 | 1220 | 36°/60° | 5000K | 40000h | ≥80 | Yes | Ø110*64.3mm cutout Ø90-95mm |
| UP-DL103-3-13W | AC230V | 13W | ≥0.9 | 895 | 36°/60° | 2700K | 40000h | ≥90 | No | Ø110*64.3mm cutout Ø90-95mm |
| UP-DL103-3-13W | AC230V | 13W | ≥0.9 | 950 | 36°/60° | 3000K | 40000h | ≥90 | No | Ø110*64.3mm cutout Ø90-95mm |
| UP-DL103-3-13W | AC230V | 13W | ≥0.9 | 1090 | 36°/60° | 4000K | 40000h | ≥90 | No | Ø110*64.3mm cutout Ø90-95mm |
| UP-DL103-3-13W | AC230V | 13W | ≥0.9 | 1080 | 36°/60° | 5000K | 40000h | ≥90 | No | Ø110*64.3mm cutout Ø90-95mm |
| UP-DL103-3-13W-D | AC230V | 13W | ≥0.9 | 845 | 36°/60° | 2700K | 40000h | ≥90 | Yes | Ø110*64.3mm cutout Ø90-95mm |
| UP-DL103-3-13W-D | AC230V | 13W | ≥0.9 | 880 | 36°/60° | 3000K | 40000h | ≥90 | Yes | Ø110*64.3mm cutout Ø90-95mm |
| UP-DL103-3-13W-D | AC230V | 13W | ≥0.9 | 1010 | 36°/60° | 4000K | 40000h | ≥90 | Yes | Ø110*64.3mm cutout Ø90-95mm |
| UP-DL103-3-13W-D | AC230V | 13W | ≥0.9 | 1010 | 36°/60° | 5000K | 40000h | ≥90 | Yes | Ø110*64.3mm cutout Ø90-95mm |

Driver data Sheet

| Driver data | DIM | Non dim |
|-----------------------------|---------------|------------|
| Input rated Voltage | AC230V | AC230V |
| Frequency | 50Hz | 50/60Hz |
| Input Voltage | AC200-240V | AC200-240V |
| Efficiency | ≥82% | ≥84% |
| Total load Wattage | 13W±1W | 13W±1W |
| Power Factor | ≥0.9 | ≥0.9 |
| Rated input current | ≤0.08A | ≤0.08A |
| Full load output Voltage | DC23-40V | DC25-42V |
| Rated output current | 280mA | 300mA |
| Output current range | 280mA±5% | 300mA±5% |
| Power tolerance | ±5% | ±5% |
| Current output tolerance | ±5% | ±5% |
| Dimming range | 8%-100% | — |
| Dimmer | Triac dimmers | — |
| Short circuit protection | PASS | PASS |
| Over voltage protection | PASS | PASS |
| Over temperature protection | PASS | PASS |
| THD | ≤18% | ≤18% |
| Withstand voltage | AC3750V | AC3750V |

Fixture Compatibility

| Rated Wattage | Electrical Classification | Ingress Protection | Operating Temp | Operating Humidity | Storage Temp |
|---------------|---------------------------|--------------------|----------------|--------------------|--------------|
| 13W | II | IP65 | -20°C~45°C | 0~90% | -20°C~65°C |

Spectral Distribution

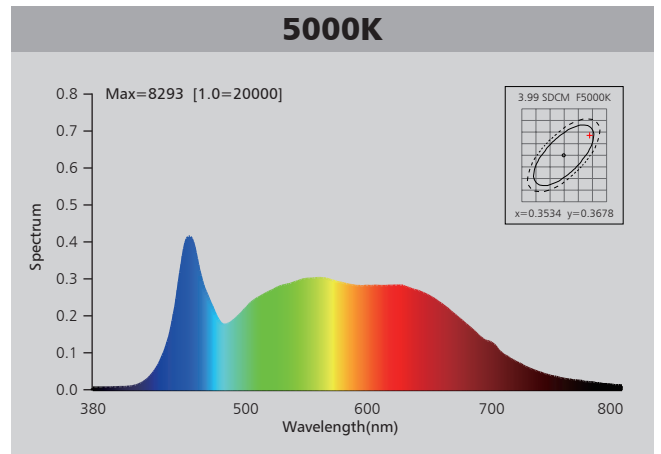
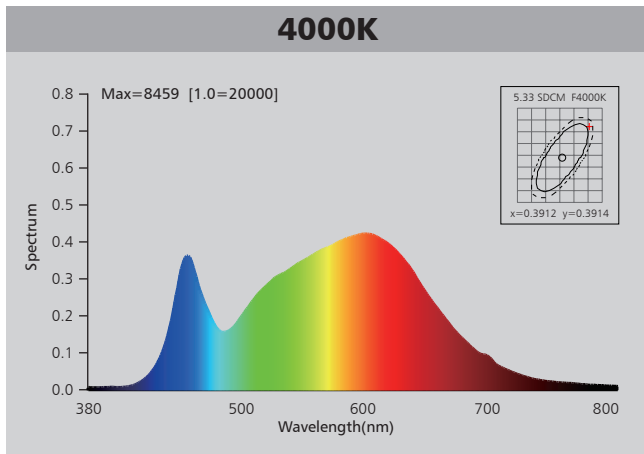
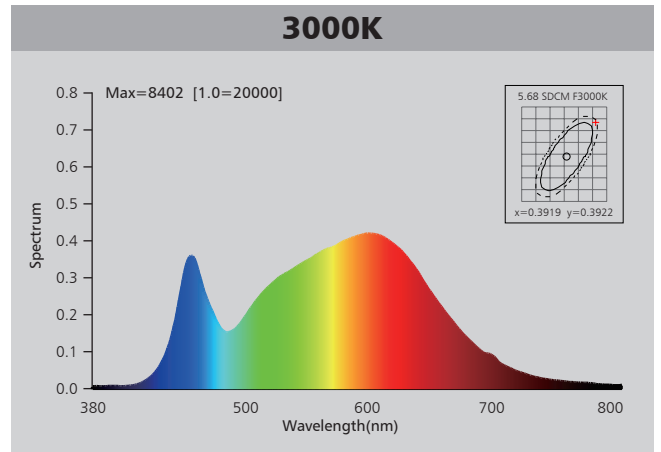
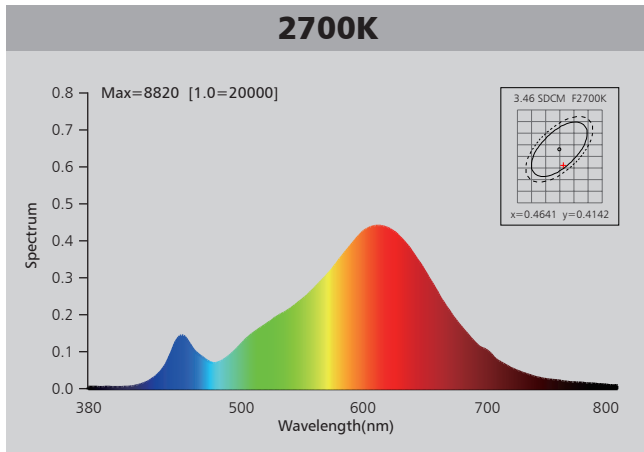

Photometric Diagram

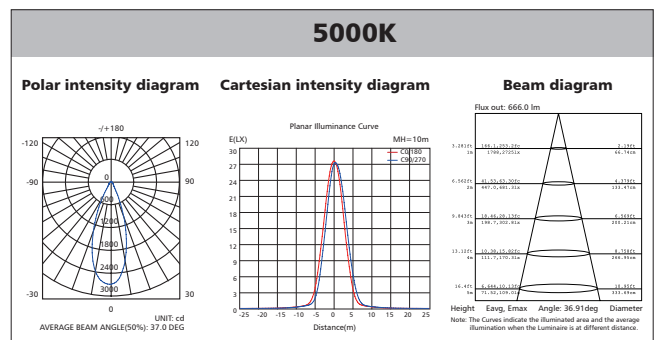
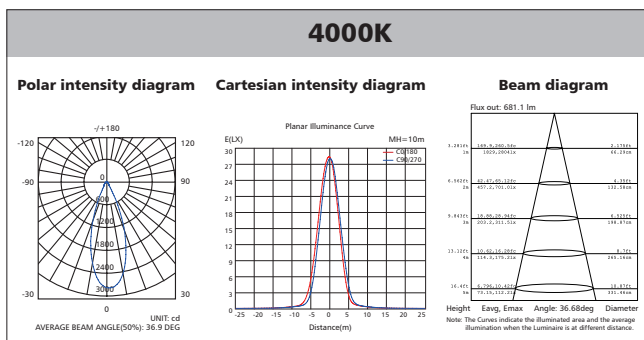
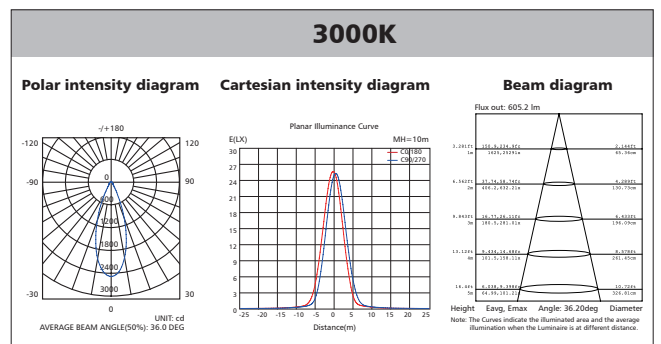
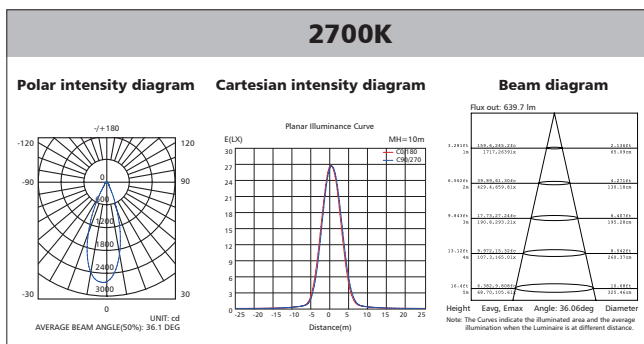

Polar Diagram Comparison

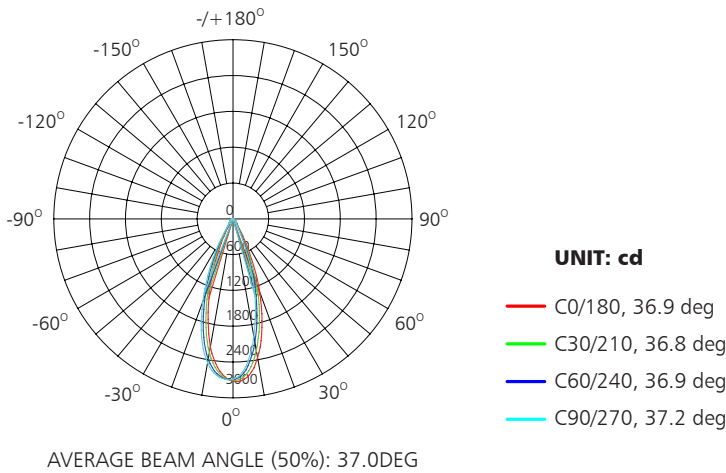

Driver lifetime & LED light decay rate

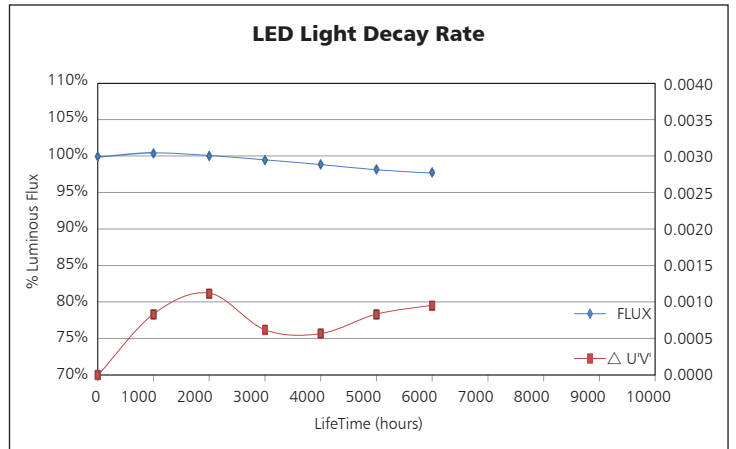
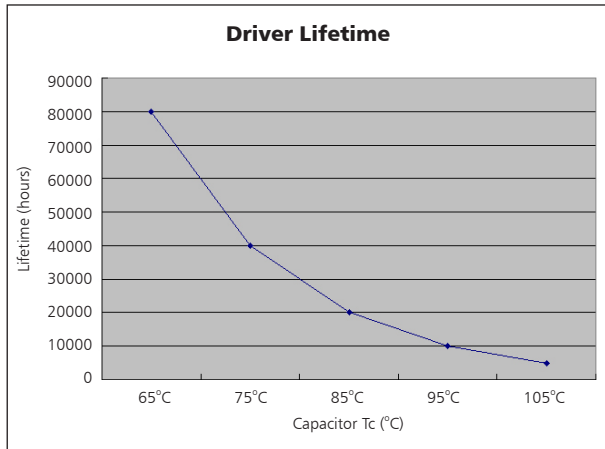

Temperature

- The testing is operated at 25°C
- The lifetime of capacitor, minimum of 5,000 hours if operated at 105°C, will be doubled whenever the temperature drops 10°C
- The highest withstand temperature of IC, MOS could be 120°C
- The highest withstand temperature of LED junction temperature is 150°C

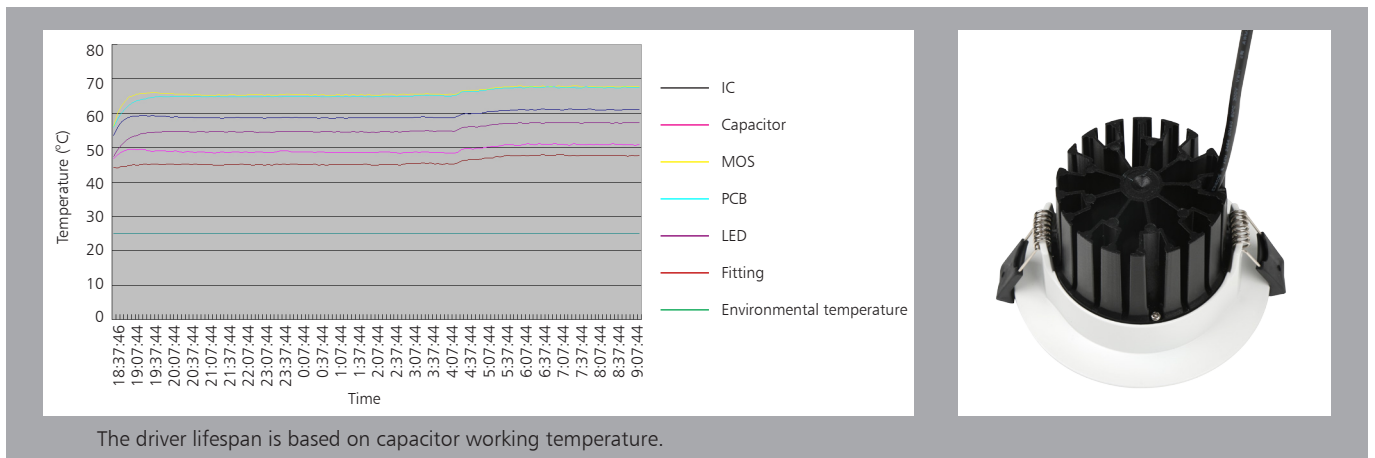

Installation

| Install requirements | |
|---------------------------------|------|
| A-gap above the fitting | 25mm |
| B-gap to the building material | 25mm |
| C-gap to the thermal insulation | 50mm |

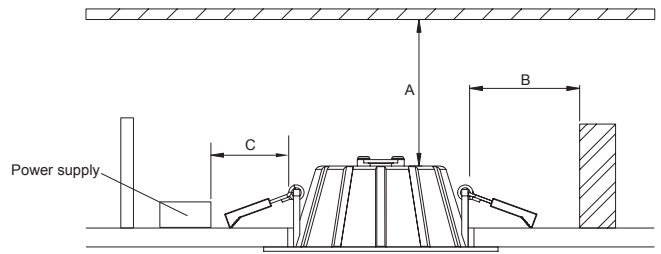

1. Open a hole according to the cutout size of led downlight.

2. Use screw-driver to open the driver terminal cover, feed the main AC wire L. N. in terminal block respectively, then fix the cover back.

3. Connect the downlight with driver, hold back the spring clip then push the downlight into the hole.

4. Make sure the downlight fixed tightly in ceiling, turn on the power (Fig 1).

Packaging Information

| | SIZE(CM) | N.W/pc (KGS) | G.W.(KGS) | Q'TY(PCS) |
|--------|----------|--------------|-----------|-----------|
| Carton | 39*28*57 | 0.45 | 16.5 | 30 |

| | CTNS | Q'TY(PCS) | VOLUME(CBM) |
|------------------------|------|-----------|-------------|
| 20" standard container | 442 | 13260 | 28 |
| 40" standard container | 884 | 26520 | 56 |

